



Instruction Manual

EN-75080C / EN-75084C 8" / 8.4" Compact Size TFT-LCD MONITOR



Please read this manual thoroughly before use, and keep it handy for future reference.

CONTENTS

SAFETY INSTRUCTION	2 ~ 3
CAUTIONS	4
FCC RF INTERFERENCE STATEMENT	5
CONNECTING WITH EXTERNAL EQUIPMENT	6
CONTROLS AND FUNCTIONS	7 ~ 24
MOUNTING GUIDE	25 ~ 26
D-SUB CONNECTOR PIN ASSIGNMENTS	27
POWER MANAGEMENT	28
SPECIFICATIONS	29
TROUBLE SHOOTING GUIDE	30

SAFETY INSTRUCTION

This Monitor was
Manufactured by ISO 9001
Certified Factory

INSTRUCTION MANUAL 1

Important Safety Instruction

1. Read these instructions.
2. Keep these Instructions.
3. Heed all warnings.
4. Follow all instructions.
5. Do not use this apparatus near water.
6. Clean only with dry cloth.
7. Do not block any ventilation openings. Install in accordance with the manufacturer's instructions.
8. Do not install near any heat sources such as radiators, heat registers, stoves, or other apparatus (including amplifiers) that produce heat.
9. Do not defeat the safety purpose of the polarized or grounding-type plug.
Apolarized plug has two blades with one wider than the other.
Agrounding type plug has two blades and a third grounding prong.
The wide blade or the third prong are provided for your safety.
If the provided plug does not fit into your outlet, consult an electrician for replacement of the bsolete outlet.

10. Protect the power cord from being walked on or pinched particularly at plugs, convenience receptacles and the point where they exit from the apparatus.
11. Only use attachment/accessories specified by the manufacturer.
12. Use only with the cart, stand, tripod, bracket or table specified by the manufacturer or sold with the apparatus. When a cart is used, use caution when moving the cart/apparatus combination to avoid injury from tip-over.
13. Unplug this apparatus during lightning storms or when unused for long periods of time.
14. Refer all servicing to qualified service personnel. Servicing is required when the apparatus has been damaged in any way, such as power-supply cord or plug is damaged, liquid has been spilled or objects have fallen into the apparatus the apparatus has been exposed to rain or moisture does not operate normally or has been dropped.



SAFETY INSTRUCTION

2 *INSTRUCTION MANUAL*

- The apparatus shall not be exposed to dripping or splashing and that no objects filled with liquids, such as vases, shall be placed on the apparatus.
- Minimum distances(e.g. 10cm) around the apparatus for sufficient ventilation.

“WARNING - To reduce the risk of fire or electric shock, do not expose the apparatus to rain or moisture.”

“The apparatus shall not be exposed to dripping or splashing and no objects filled with liquids, such as vases, shall be placed on the apparatus.”

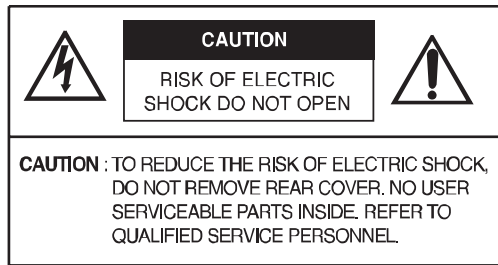

This symbol is intended to alert the user to the presence of uninsulated : dangerous voltage with in the product's enclosure that may be of sufficient magnitude to constitute a risk of electric shock to persons.



This symbol is intended to alert the user to the presence of important operating and maintenance(servicing) instructions in the literature accompanying the appliance.

CAUTIONS

INSTRUCTION MANUAL **3**

CAUTION

The power supply cord is used as the main disconnect device, ensure that the socket-outlet is located/installed near the equipment and is easily accessible.

ATTENTION

Le cordon d'alimentation est utilisé comme interrupteur général. La prise de courant doit être située ou installée à proximité du matériel et être facile d'accès

CAUTION TO SERVICE PERSONNEL

POWER SUPPLY CORD IS USED AS MAIN POWER DISCONNECT DEVICE IN THIS PRODUCT. UNPLUG THIS PRODUCT FROM THE WALL OUTLET BEFORE REMOVING THE BACK COVER AND SERVICING

EMISSION CHARACTERISTICS TESTED BY SEMKO

THIS PRODUCT HAS BEEN TESTED AND HAS SHOWN COMPLIANCE WITH THE NATIONAL SPECIFICATIONS SUCH AS SWEDISH MPR 1990.10.(MPR II)

NEVER REMOVE THE BACK COVER

Removal of the back cover should be carried out only by qualified personnel.

DO NOT USE IN HOSTILE ENVIRONMENTS

To prevent shock or fire hazard, do not expose the unit to rain or moisture.

This unit is designed to be used in the office or home. Do not subject the unit to vibrations, dust of corrosive gases.

KEEP IN A WELL VENTILATED PLACE

Ventilation holes are provided on the cabinet to prevent the temperature from rising.

Do not cover the unit or place anything on the top of unit.

AVOID HEAT

Avoid placing the unit in direct sunshine or near a heating appliance.

TO ELIMINATE EYE FATIGUE

Do not use the unit against a bright back ground and where sunlight or other light sources will shine directly on the monitor.

BE CAREFUL OF HEAVY OBJECT

Neither the monitor itself nor any other heavy object should rest on the power cord.

FCC RF INTERFERENCE STATEMENT

Damage to a power cord can cause fire or electrical shock.

NOTE

This equipment has been tested and found to comply with the limits for a Class A digital device, pursuant to Part 15 of the FCC Rules. These limits are designed to provide reasonable protection against harmful interference in a residential installation.

This equipment generates, uses and can radiate radio frequency energy and, if not installed and used in accordance with the instructions, may cause harmful interference to radio communications. However, there is no guarantee that interference will not occur in a particular installation.

If this equipment does cause harmful interference to radio or television reception which can be determined by turning the equipment off and on, the user is encouraged to try to correct the interference by one or more of the following measures.

- Reorient or relocate the receiving antenna.
- Increase the separation between the equipment and receiver.
- Connect the equipment into an outlet on a circuit different from that to which the receiver is connected.
- Consult the dealer or an experienced radio, TV technician for help.
- Only shielded interface cable should be used.

Finally, any changes or modifications to the equipment by the user not expressly approved by the grantee or manufacturer could void the users authority to operate such equipment.

□ DOC COMPLIANCE NOTICE

This digital apparatus does not exceed the Class A limits for radio noise emissions from digital apparatus set out in the radio interference regulation of Canadian Department of communications.

CONNECTING WITH EXTERNAL EQUIPMENT

A. BACK

1. TRIGGER INPUT

Sensor Signal Input

2. AUDIO IN

3.5Φ STEREO IN

3. S-VIDEO IN

Y/C separated signal input

4. AV1 OUT

Video looping output for AV1

5. AV1 IN

Composite signal Input for AV1

6. AV2 OUT

Video looping output for AV2

7. AV2 IN

Composite signal Input for AV2

8. VGA

PC Analog Signal Input

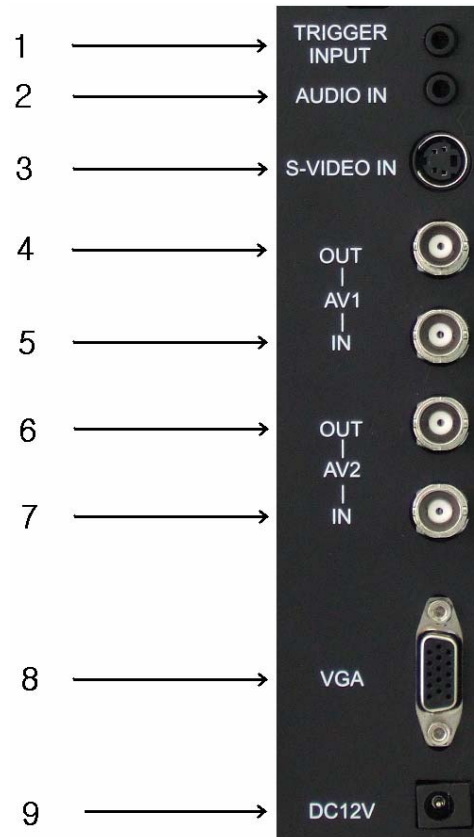

CONTROLS AND FUNCTIONS

B. FRONT

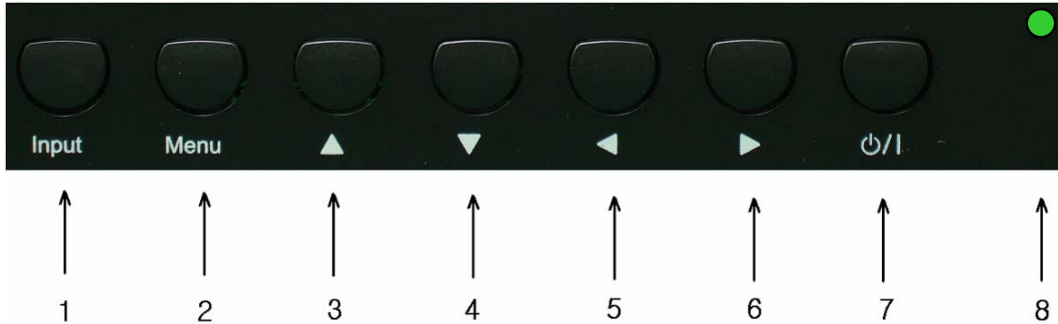

1. INPUT

Select input source.

2. MENU

Activates and exits the On Screen Display.

This button can also be used to move previous menu or status.

OSD MENU(MAIN) : Input Source, Screen, Audio, OSD, Color, Utility, Exit.

3/4. ▲ / ▼

This button allows user to enter the sub-menu of the activated function

▼ : Auto geometry adjustment in PC Source.

5/6. ◀ / ▶

Adjust the volume / Adjust menu settings.

7. POWER ON/OFF

Turns the power ON or OFF. There will be a few seconds delay before the display appears.

8. POWER LED

The power LED(next to the power switch) lights with green when the power is turned ON.

The power is turned off by pressing the power switch again and the power LED goes to Red.

CONTROLS AND FUNCTIONS

OSD Menu Description

A: CUSTOM MENU (For AV1, AV2 & S-Video Input)



- 1) Press the MENU button and then press the up(▲) or down(▼) button to select the Custom.
- 2) Press the up(▲) or down(▼) button to select the sub menu.
- 3) Press the left(◀) or right(▶) button to adjust the picture setting.
- 4) Press the MENU button to save.

Brightness: Increase or decrease the intensity of the image.

Contrast: Increase or decrease the intensity (lightness or dimness) of the image.

Color: Increase or decrease the colour of the picture.

Tint: Increase or decrease the tint of the picture.

Sharpness: Increase or decrease the sharpness of the picture.

A: CUSTOM MENU (PC Input)



- 1) Press the MENU button and then press the up(▲) or down(▼) button to select the Custom.
- 2) Press the up(▲) or down(▼) button to select the sub menu.

CONTROLS AND FUNCTIONS

- 3) Press the left(◀) or right(▶) button to adjust the picture setting.
- 4) Press the MENU button to save.

B. Picture / Sound Menu (For AV1, AV2 & S-Video)

1. Picture Mode

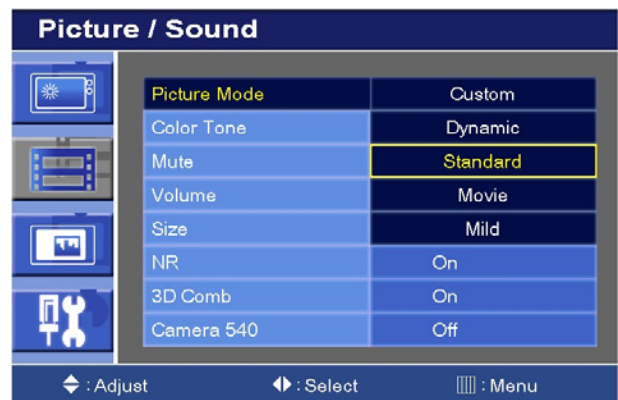
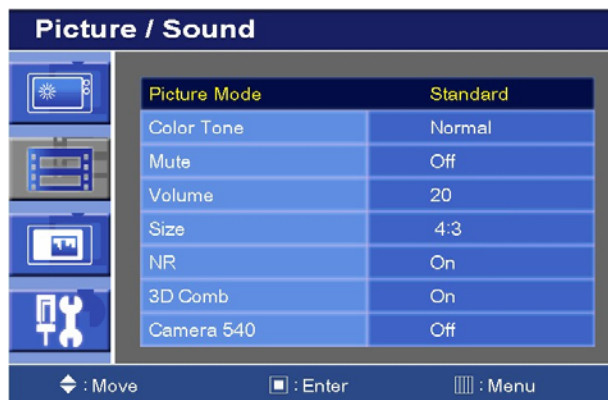

- 1) Press the MENU button and then press the up(▲) or down(▼) button to select the Picture / Sound.

- 2) Press the right(▶) or INPUT button.
- 3) Press the up(▲) or down(▼) button to select the Picture Mode.
- 4) Press the right(▶) or INPUT button.
- 5) Press the up(▲) or down(▼) button to select the Picture Mode option.
- 6) Press the MENU button to save

2. Color Tone

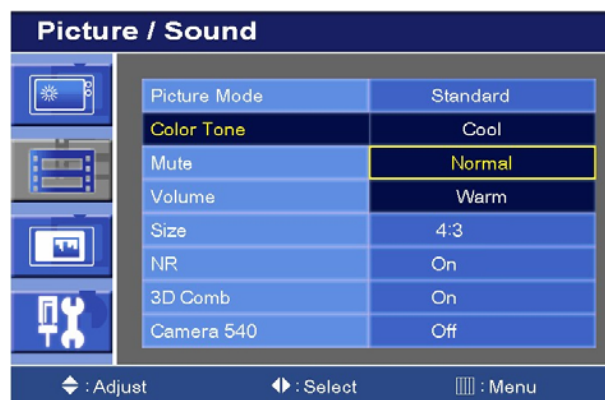
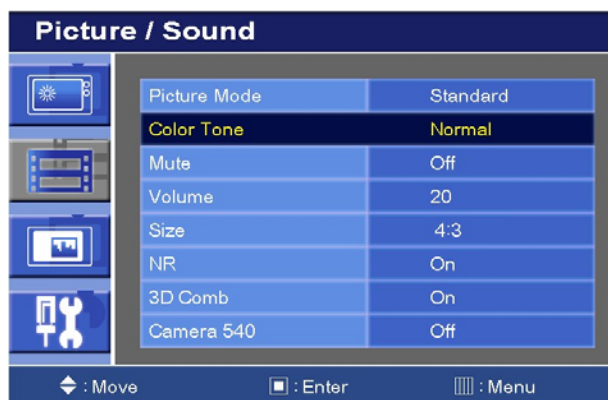

- 1) Press the up(▲) or down(▼) button to select the Color Tone.
- 2) Press the right(▶) or INPUT button.
- 3) Press the up(▲) or down(▼) button to select the Color Tone option.

CONTROLS AND FUNCTIONS

- 4) Press the MENU button to save.

3. Mute

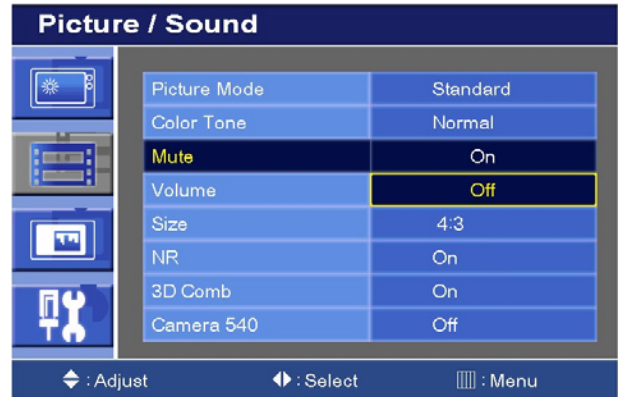
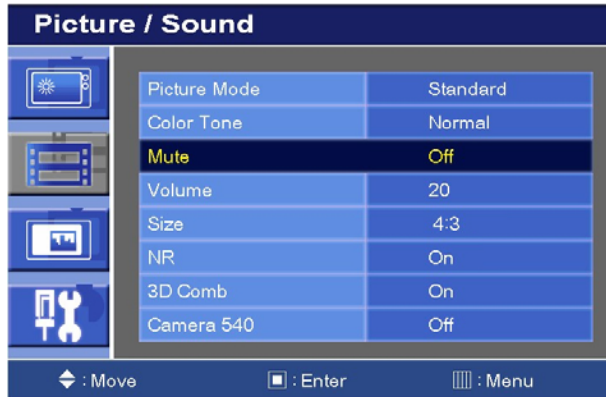

- 1) Press the up(▲) or down(▼) button to select the Mute.
- 2) Press the right(▶) or INPUT button.
- 3) Press the up(▲) or down(▼) button to select the On or Off.
- 4) Press the MENU button to save.

4. Volume



- 1) Press the up(▲) or down(▼) button to select the Volume
- 2) Press the left(◀) or right(▶) button to adjust Volume setting.
- 3) Press the MENU button to save.

CONTROLS AND FUNCTIONS

5. Size

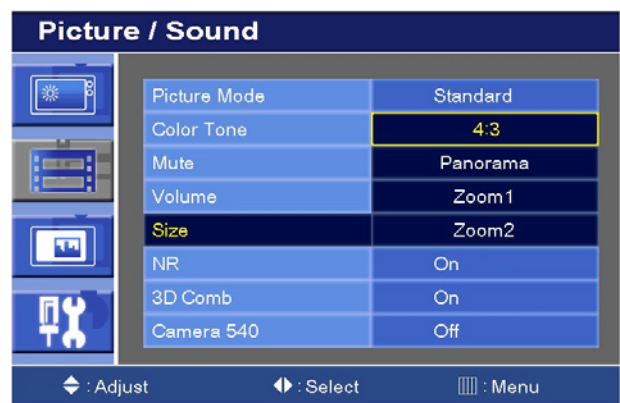
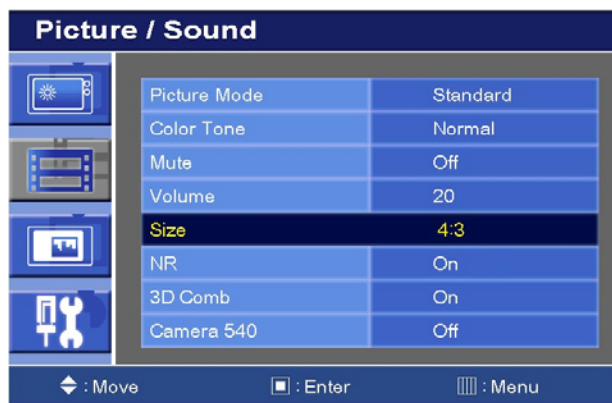

- 1) Press the up(▲) or down(▼) button to select the Size
- 2) Press the right(▶) or INPUT button.
- 3) Press the up(▲) or down(▼) button to select the Size option.
- 4) Press the MENU button to save.

6. NR

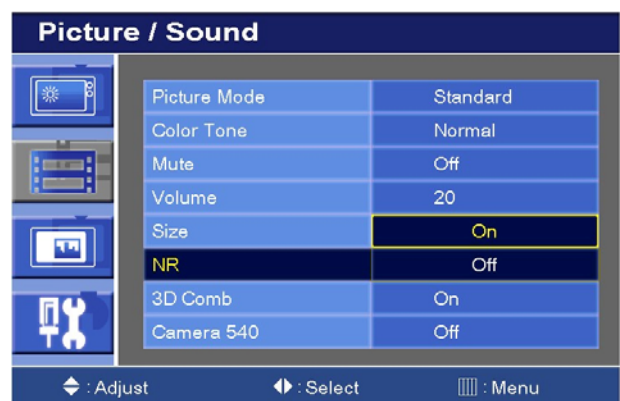
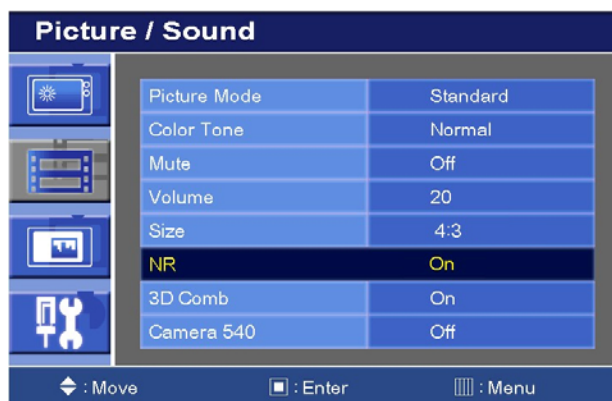

- 1) Press the up(▲) or down(▼) button to select the NR.
- 2) Press the right(▶) or INPUT button.
- 3) Press the up(▲) or down(▼) button to select the On or Off.
- 4) Press the MENU button to save.

CONTROLS AND FUNCTIONS

7. 3D Comb

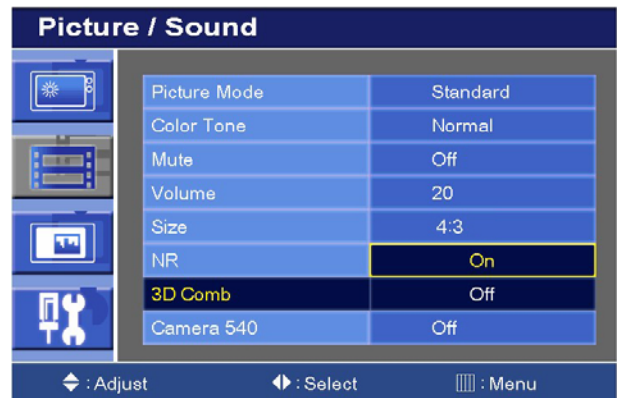

- 1) Press the up(▲) or down(▼) button to select the 3D Comb.
- 2) Press the right(▶) or INPUT button.
- 3) Press the up(▲) or down(▼) button to select the On or Off.
- 4) Press the MENU button to save.

8. Camera 540

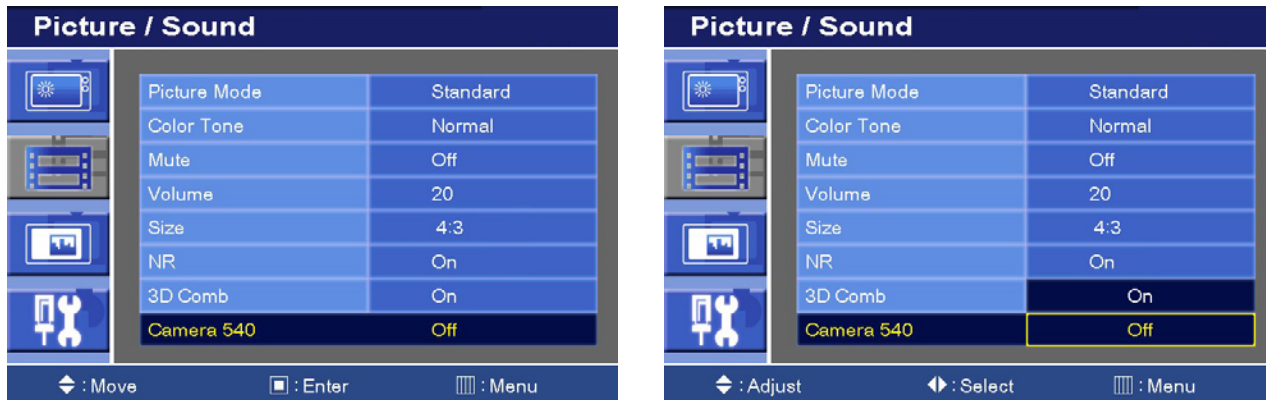

- 3) Press the up(▲) or down(▼) button to select the Camera 540 menu.
- 4) Press the right(▶) or INPUT button.
- 5) Press the up(▲) or down(▼) button to select the Camera 540 option.
- 6) Press the MENU button to save.

CONTROLS AND FUNCTIONS

B. Picture / Sound Menu (For PC Input)

1. Picture Mode

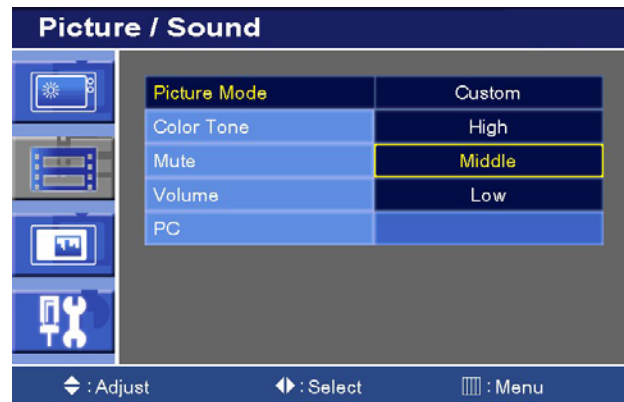
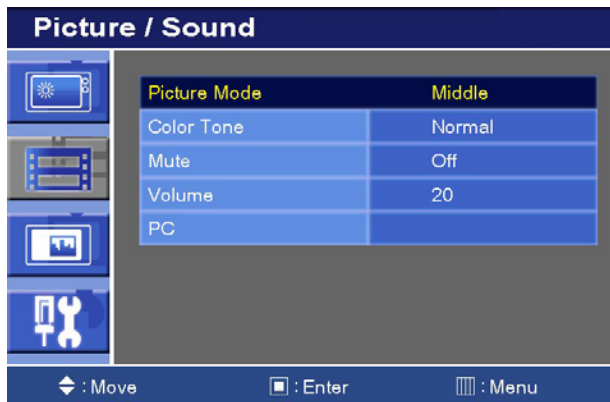

- 1) Press the MENU button and then press the up(▲) or down(▼) button to select the Picture/Sound.
- 2) Press the right(▶) or INPUT button.
- 3) Press the up(▲) or down(▼) button to select the Picture Mode.
- 4) Press the right(▶) or INPUT button.
- 5) Press the up(▲) or down(▼) button to select the Picture Mode option.
- 6) Press the MENU button to save.

2-1. Color Tone

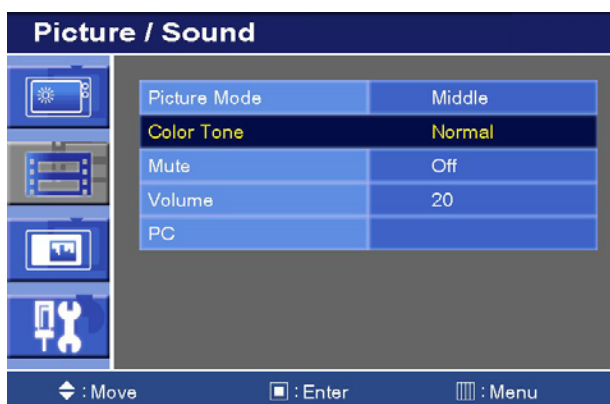

- 1) Press the up(▲) or down(▼) button to select the Color Tone.
- 2) Press the right(▶) or INPUT button.

CONTROLS AND FUNCTIONS



- 3) Press the left(▶) or INPUT button again.
- 4) Press the up(▲) or down(▼) button to select the Color Tone option.
- 5) Press the MENU button to save.

2-2. Color Tone (Custom)

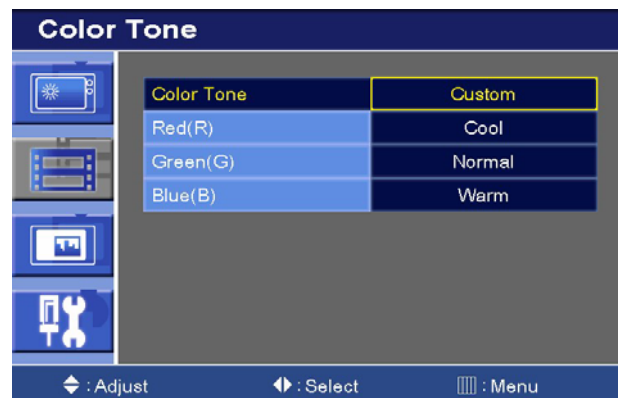

- 1) Press the up(▲) or down(▼) button to select the Custom in the Color Tone.

2) Press the Menu button to save.

CONTROLS AND FUNCTIONS



3) Press the up(▲) or down(▼) button to select the Red(R), Green(G) or Blue(B).

4) Press the left(◀) or right(▶) button to adjust color density.

5) Press the MENU button to save.

4. PC control (Only PC Input)

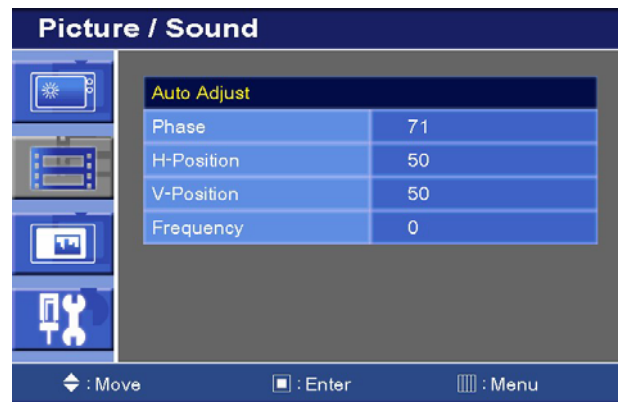
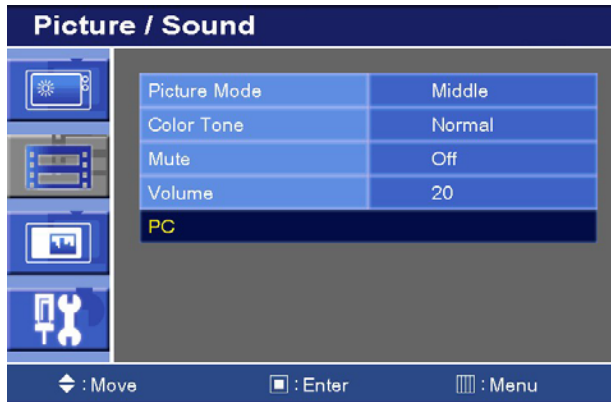

- 1) Press the up(▲) or down(▼) button to select the PC.
- 2) Press the right(▶) or INPUT button.
- 3) Press the up(▲) or down(▼) button to select the PC sub menu.
- 4) Press the right(▶) or INPUT button.
- 5) Press the left(◀) or right(▶) button to adjust the PC setting.
- 6) Press the MENU button to save.

Auto Adjust: Auto geometry adjustment.

Phase: Adjust the number of horizontal picture elements.

CONTROLS AND FUNCTIONS

H-Position: Move image horizontally on screen right or left.

V-Position: Move image vertically on screen up or down.

Frequency: Adjust the vertical noise of screen image.

C. SETUP MENU



1) Press the MENU button and then press the up(▲) or down(▼) button to select the Setup.

1. Reset



- 1) Press the right(▶) or INPUT button
 - 2) Press the right(▶) or INPUT button again.
 - 3) Press INPUT button to execute the reset.
- Reset:** All settings go to the factory initialization.

CONTROLS AND FUNCTIONS

2. Language



- 1) Press the up(▲) or down(▼) button to select the Language.
- 2) Press the right(□) or INPUT button.
- 3) Press the up(▲) or down(▼) button to select language.
- 4) Press the MENU button to save.

3. OSD Tone

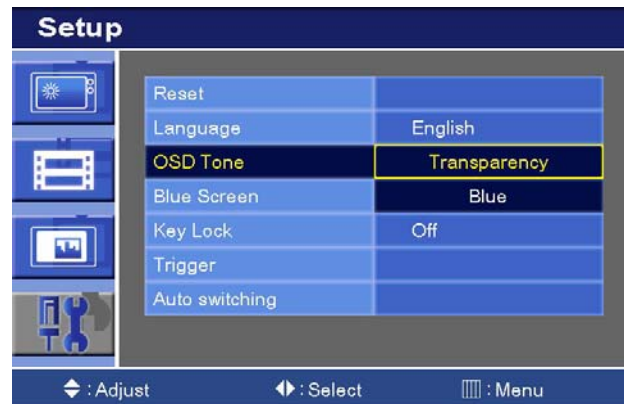

- 1) Press the up(▲) or down(▼) button to select the OSD Tone.
- 2) Press the right(□) or INPUT button
- 3) Press the up(▲) or down(▼) button to select the OSD Tone option.
- 4) Press the MENU button to save.

CONTROLS AND FUNCTIONS

4. Blue Screen

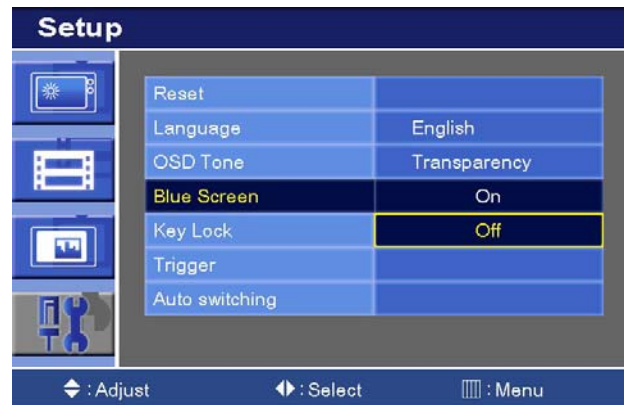

- 1) Press the up(▲) or down(▼) button to select the Blue Screen.
- 2) Press the right(▶) or INPUT button.
- 3) Press the up(▲) or down(▼) button to select the On or Off.
- 4) Press the MENU button to save.

5. Key Lock



- 1) Press the up(▲) or down(▼) button to select the Key Lock.
- 2) Press the right(▶) or INPUT button
- 3) Press the up(▲) or down(▼) button to select the On or Off
- 4) Press the MENU button to save.

※ How to unlock

- 1) **On the front key:** Press the INPUT and MENU button at the same time over 3 seconds.
- 2) **On the Remote Controller:** The Remote Controller operates well because the Key Lock function is only allowed for the front key of this product.

CONTROLS AND FUNCTIONS

6. Trigger



- 1) Press the up(▲) or down(▼) button to select the Trigger.
- 2) Press the right(▶) or INPUT button.

6-1. Trigger Enable



- 1) Press the up(▲) or down(▼) button to select the Trigger Enable.
- 2) Press the right(▶) or INPUT button.
- 3) Press the up(▲) or down(▼) button to select the On or Off.
- 4) Press the Menu button to save.

CONTROLS AND FUNCTIONS

6-2. Trigger Input

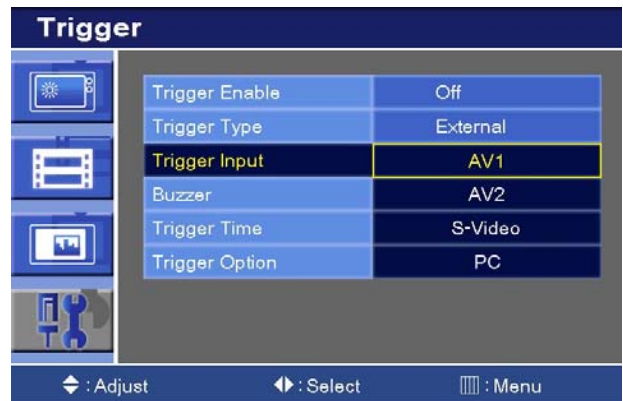

- 1) Press the up(▲) or down(▼) button to select the Trigger Input .
- 2) Press the right(□) or INPUT button.
- 3) Press the up(▲) or down(▼) button to select the Trigger Input option.
- 4) Press the Menu button to save.

6-3. Buzzer

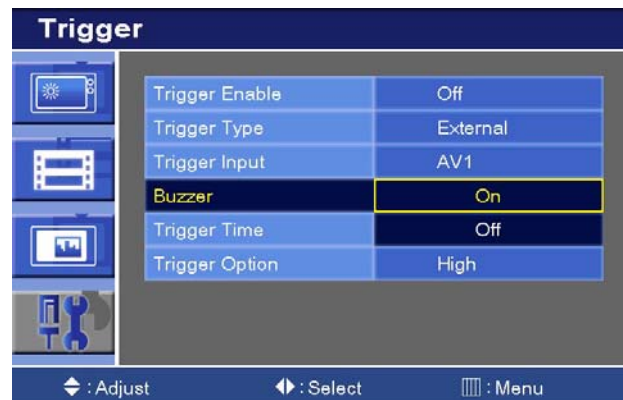

- 1) Press the up(▲) or down(▼) button to select the Buzzer.
- 2) Press the right(□) or INPUT button.
- 3) Press the up(▲) or down(▼) button to select the On or Off.
- 4) Press the Menu button to save.

CONTROLS AND FUNCTIONS

6-4. Trigger Time



- 1) Press the up(▲) or down(▼) button to select the Trigger Time.
- 2) Press left(◀) or right(▶) button to adjust Trigger Time setting.
- 3) Press the MENU button to save.

6-5 Trigger Option



- 1) Press the up(▲) or down(▼) button to select the Trigger Option.
- 2) Press the right(◻) or INPUT button.
- 3) Press the up(▲) or down(▼) button to select the Trigger Option setting.
- 4) Press the Menu button to save.

N/C (Normal Closed): When Trigger cable is opened, Trigger function is activated.
N/O (Normal Opened): When Trigger cable is closed, Trigger function is activated.
High: When Trigger signal is high(2~5[V]), Trigger function is activated.

CONTROLS AND FUNCTIONS

Low: When Trigger signal is low(0~0.6[V]), Trigger function is activated.

7. Auto switching



- 1) Press the up(▲) or down(▼) button to select the Auto switching.
- 2) Press the right(▶) or INPUT button.

7-1. Auto switching On/Off

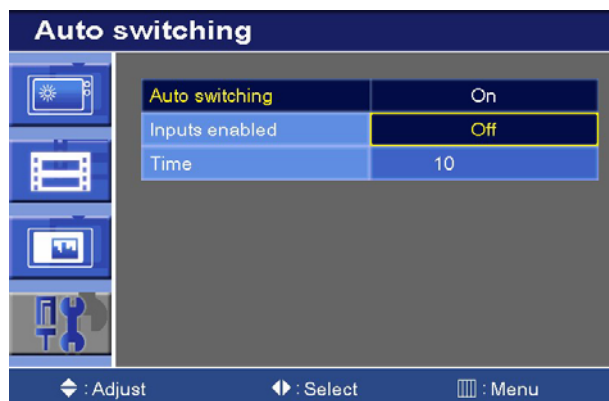
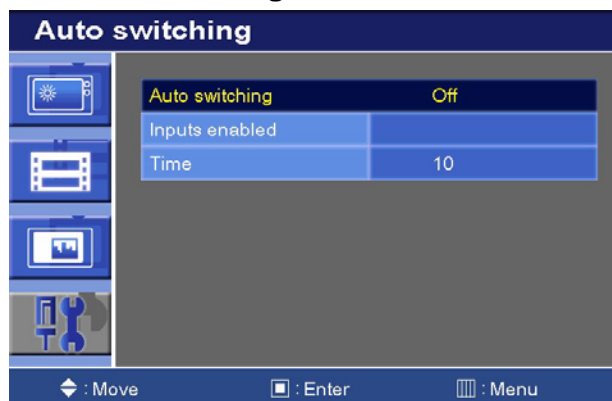

- 1) Press the right(□) or INPUT button.
- 3) Press the up(▲) or down(▼) button to select the On or Off .
- 4) Press the Menu button to save.

CONTROLS AND FUNCTIONS

7-2. Auto switching Inputs enabled

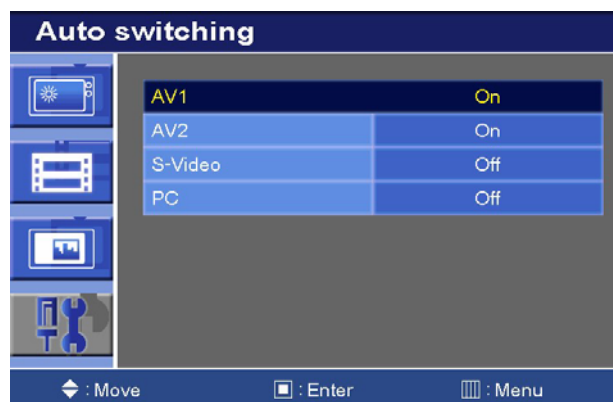
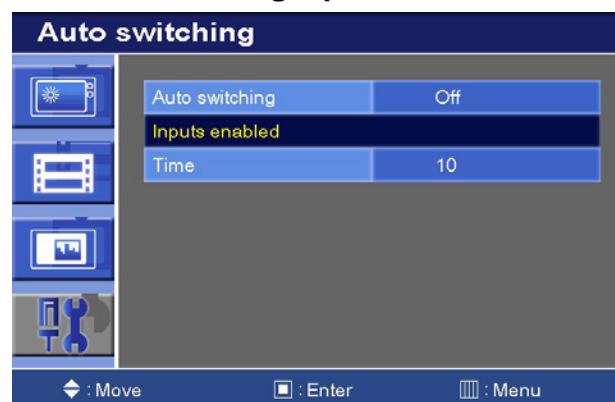

- 1) Press the up(▲) or down(▼) button to select the Inputs enabled.
- 2) Press the right(□) or INPUT button.
- 3) Press the up(▲) or down(▼) button to select the Input.
- 4) Press the right(□) or INPUT button.

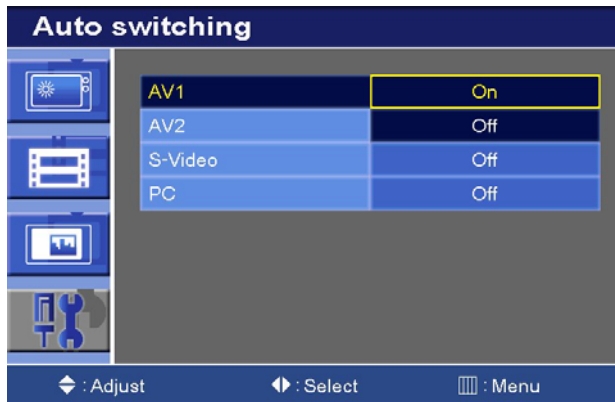

5) Press the up(▲) or down(▼) button to select the On or Off and then press the Menu button to save.

CONTROLS AND FUNCTIONS

7-3. Auto switching Time

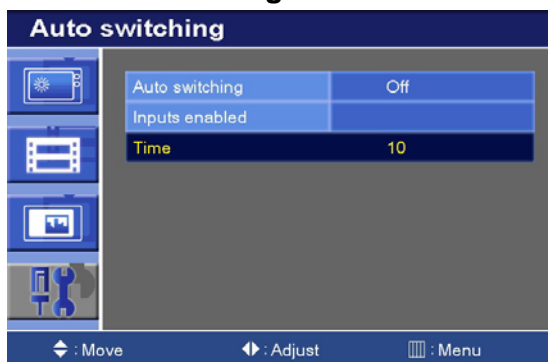

1) Press the up(▲) or down(▼) button to select the Time.

2) Press the left(◀) or right(▶) button to adjust the Time and then press the MENU button to save.

MOUNTING GUIDE

A. Wall mount(Optional)

- 1) Using the 75 mm VESA holes.
- 2) Using the VESA standard wall mount design and the 75mm hole pattern on the back side to install the LCD monitor to the wall.

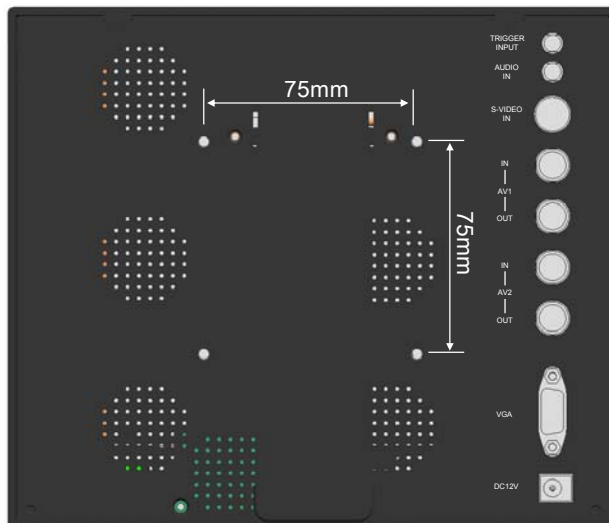

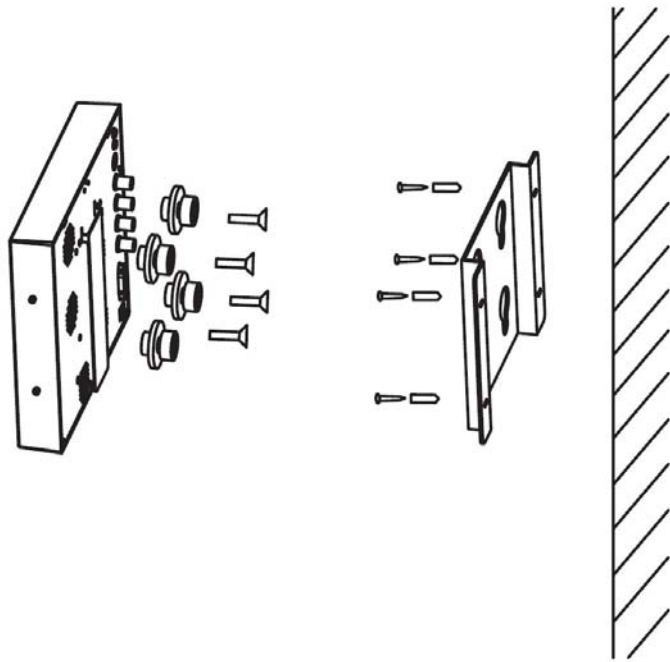

MOUNTING GUIDE

B. Rack mount(Optional)

- 1) Install the monitor in the Pre-Rack using the 75 mm VESA holes.
- 2) Install the Pre-Rack in the Open Rack using side mounting holes.

※ The Pre-Rack is available rotation of 360° on the Open Rack.

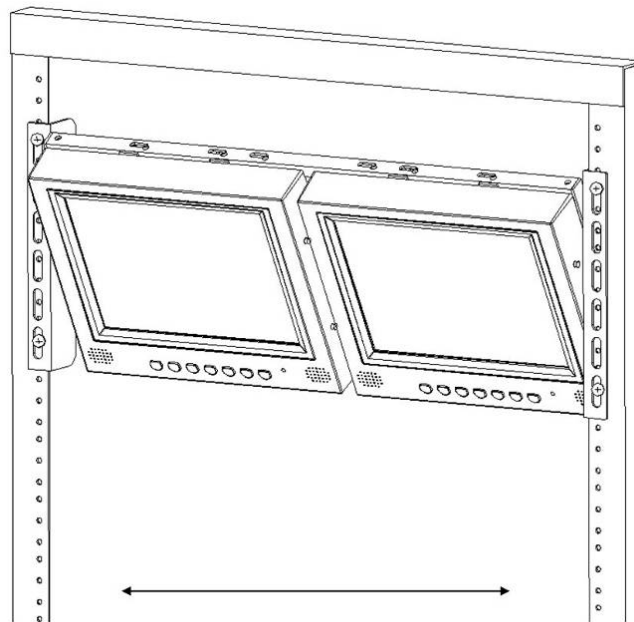
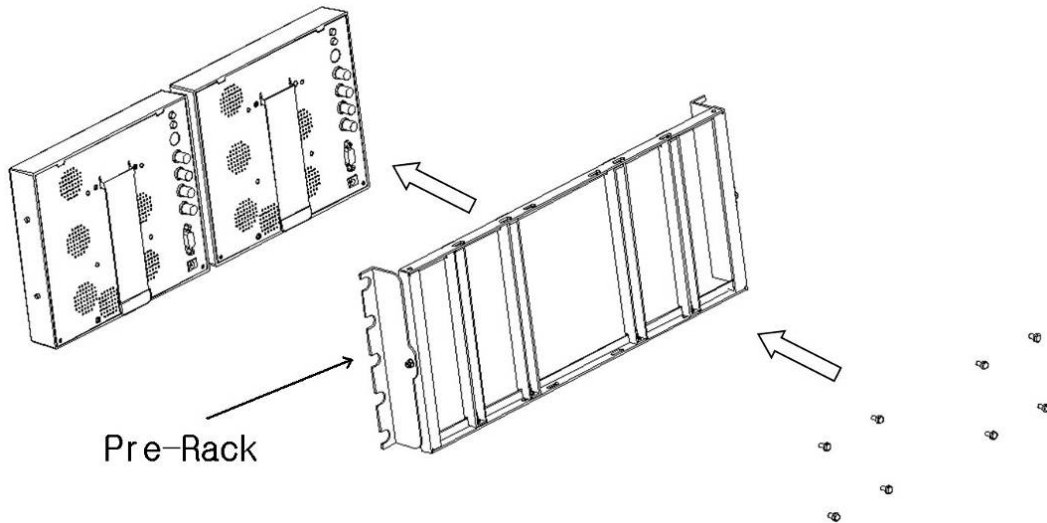

19" EIA STANDARD OPEN RACK

D-SUB CONNECTOR PIN ASSIGNMENTS

▶ PIN ASSIGNMENTS

Pin 1	RED VIDEO	9	
2	GREEN VIDEO	10	SIGNAL CABLE DETECT
3	BLUE VIDEO	11	GROUND
4	GROUND	12	SDA(for DDC)
5	GROUND	13	H-SYNC.(or H+V SYNC.)
6	RED GROUND	14	V-SYNC.
7	GREEN GROUND	15	SCL(for DDC)
8	BLUE GROUND		

D-SUB

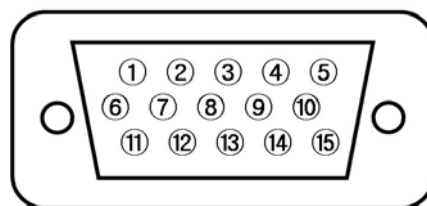

ACCESSORY

1. POWER CORD
2. USER'S MANUAL
3. PC cable
4. Adaptor
5. Trigger Cable(Optional)
6. Wall mount (Option)
7. Rack mount (Option)

POWER MANAGEMENT

This monitor features a power management system to “power down” upon receipt of the VESA DPMS(The display power management signaling) from a VESA DPMS video card.

The VESA DPMS-compliant video card performs this signaling system through not sending horizontal, vertical, or sync signal.

This monitor enters an appropriate mode through identifying each of the three modes of the signaling system.

POWER CONSUMPTION

MODE	POWER CONSUMPTION
ON	< 21W
STANDBY	< 20.5W
SUSPEND	< 20.5W
ACTIVE OFF	< 9.5W

LED INDICATOR

The power management feature of the monitor is comprised of four stages: On(Green), Standby, Suspend, Active off(Red on/off 1 sec) and Unsupported mode(Green).

MODE	LED COLOR	MONITOR OPERATION
ON	GREEN	Normal Operation
STANDBY	RED ON/OFF 1 SEC	Screen blanks after preset idle time And some electronic circuits or all Circuitry in the monitor shut down.
SUSPEND		
ACTIV OFF		

UNSUPPORTES MODE	GREEN	Normal operation but the on screen Display will show error massage
POWER OFF	RED	Not Operation

SPECIFICATIONS

	8RTC	8RTF'
LCD-Type	8" Diagonal AM-TFT(Active-Matrix)	8.4" Diagonal AM-TFT(Active-Matrix)
	Pixel pitch(mm) : 0.2025(H) x 0.2025(V)	Pixel pitch(mm) : 0.213(H) x 0.213(V)
	BRIGHTNESS: 250cd/m ² (Typical)	BRIGHTNESS: 600cd/m ² (Typical)
	CONTRAST RATIO: 500:1(Typical)	CONTRAST RATIO: 600:1(Typical)
	RESPONSE TIME: 25msec(Typical)	RESPONSE TIME: 25msec(Typical)
RESOLUTION (H x V)	800X600 @60Hz	
FREQUENCY	HORIZONTAL: 37.5KHz, VERTICAL: 60Hz	
INPUT SIGNAL	VIDEO(2ch input 1.0Vp-p, 75Ω terminated, loop-through out)	
	SYNC(Separate TTL Level)	
	S-VIDEO(1ch input (Y/C))	
	3.5Φ Stereo Sound	

ACTIVE DISPLAY AREA (H x V)	162mm x 121.5mm	170.4mm X 127.8mm
PACKING DIMENSIONS (W x D x H)	215.3mm x 40.4mm x 184.3mm	215.3mm X 40.4mm X 184.3mm
WEIGHT	Net Weight : 1.1Kg	Net Weight : 1.19Kg
	Gross Weight : 2.25Kg	Gross Weight : 2.34Kg
ELECTRICAL RATINGS	DC 12V/ 3.33A	DC 12V/ 3.33A

TROUBLESHOOTING GUIDE

►► **NOTE :**

Technical specifications are subject to change without notice.

TROUBLE	TROUBLESHOOTING TIP
No image on display screen	<ol style="list-style-type: none"> 1. Check that power cord of the Monitor have been connected securely into wall outlet or grounded extension cable or strip. 2. Power switch should be in the ON position and LED is lit. 3. Check that the Brightness and/or the Contrast adjustments of the Display have not been turned down to minimum levels.
"Going to Sleep" message on screen	<ol style="list-style-type: none"> 1. The signal cable should be completely connected to the video card/computer. 2. The video card should be completely seated in its slot and the computer is switched ON.
Display image is not centered, too small or too large in PC mode	Push the down key in front side or Auto key in remote controller.
Vertical or Horizontal noise is present in the picture	Adjust Clock and Phase in the OSD.

WEEE Symbols

Correct Disposal of This Product (Waste Electrical & Electronic Equipment)

(Applicable in the European Union and other European countries with separate collection systems)

This marking shown on the product or its literature, indicates that it should not be disposed with other household wastes at the end of its working life. To prevent possible harm to the environment or human health from uncontrolled waste disposal, please separate this from other types of wastes and recycle it responsibly to promote the sustainable reuse of material resources. Household users should contact either the retailer where they purchased this product, or their local government office, for details of where and how they can take this item for environmentally safe recycling. Business users should contact their supplier and check the terms and conditions of the purchase contract. This product should not be mixed with other commercial wastes for disposal.



EverFocus Electronics Corp.

Taiwan - Headquarter Office

12F, No.79 Sec.1 Shin-Tai Wu Road,
Hsi-Chi, Taipei, Taiwan
Tel: +886-2-26982334
Fax: +886-2-26982380

China - Beijing Office

Room 609, Technology Trade Building,
Shangdi Information Industry Base,
Haidian District, Beijing China
Tel: +86-10-62971096
Fax: +86-10-62971423

Europe - Germany Office

Albert-Einstein-Strasse 1,
D-46446 Emmerich, Germany
Tel: +49-2822-9394-0
Fax: +49-2822-939495

Japan Office

1809 WBG Marive East 18F,
2-6 Nakase, Mihama-ku,
Chiba City 261-7118, Japan
Tel: +81-43-212-8188
Fax: +81-43-297-0081

USA - California Office

1801 Highland Ave. Unit A
Duarte, CA 91010 ,U.S.A
Tel: +1-626-844-8888
Fax: +1-626-844-8838

USA - New York Office

415 Oser Ave Unit S
Hauppauge, NY 11788
Sales: +1-631-436-5070
Fax: +1-631-436-5027

	<p>Your EverFocus product is designed and manufactured with high quality materials and components which can be recycled and reused.</p> <p>This symbol means that electrical and electronic equipment, at their end-of-life, should be disposed of separately from your household waste.</p> <p>Please, dispose of this equipment at your local community waste collection/recycling centre.</p> <p>In the European Union there are separate collection systems for used electrical and electronic product.</p> <p>Please, help us to conserve the environment we live in!</p>	<p>Ihr EverFocus Produkt wurde entwickelt und hergestellt mit qualitativ hochwertigen Materialien und Komponenten, die recycelt und wieder verwendet werden können.</p> <p>Dieses Symbol bedeutet, dass elektrische und elektronische Geräte am Ende ihrer Nutzungsdauer vom Hausmüll getrennt entsorgt werden sollen.</p> <p>Bitte entsorgen Sie dieses Gerät bei Ihrer örtlichen kommunalen Sammelstelle oder im Recycling Centre.</p> <p>Helfen Sie uns bitte, die Umwelt zu erhalten, in der wir leben!</p>
---	--	---



P/N: L39ME0138 Rev.2